



Dynamic Ballast Corp.
 41 Smith Street
 Englewood, NJ 07631
 www.DYnamicballast.com

ELECTRONIC BALLAST

DATA SHEET

DY 232 IS 277

Starting Method: Instant Start
 Connection: Parallel
 Input Voltage: 277
 Input Frequency: 50/60 Hz
 Model #: DY232IS277

Lamp Type	Number of Lamps	Rated Lamp Watts	Min. Start Temp. (°C)	Input Current (Amps)	Input Power (Watts)	Ballast Factor	Max THD %	Min. Power Factor	Max. LCCF	B.E.F
F17T8	1	17	0/-18	0.07	21	0.92	15	98%	1.7	4.38
F17T8	2	17	0/-18	0.12	33	0.87	15	96%	1.7	2.64
F25T8	1	25	0/-18	0.10	29	1.01	10	98%	1.7	3.48
F25T8	2	25	0/-18	0.17	45	0.87	10	98%	1.7	1.93
F32T8	1	32	0/-18	0.13	34	0.92	10	98%	1.7	2.71
F32T8	2	32	0/-18	0.21	58	0.87	10	98%	1.7	1.50
F40T8	1	40	0/-18	0.15	43	1.02	10	98%	1.7	2.37
FB16T8	1	16	0/-18	0.07	19	0.90	15	98%	1.7	4.74
FB16T8	2	16	0/-18	0.11	30	0.87	15	96%	1.7	2.90
FB24T8	1	24	0/-18	0.10	27	0.92	10	98%	1.7	3.41
FB24T8	2	24	0/-18	0.15	43	0.87	10	98%	1.7	2.02
FB31T8	1	31	0/-18	0.12	35	0.95	10	98%	1.7	2.71
FB31T8	2	31	0/-18	0.20	57	0.87	10	98%	1.7	1.53
FT40T5	1	40	0/-18	0.13	38	0.95	10	98%	1.7	2.50

Wiring Diagram: Diagram B&A

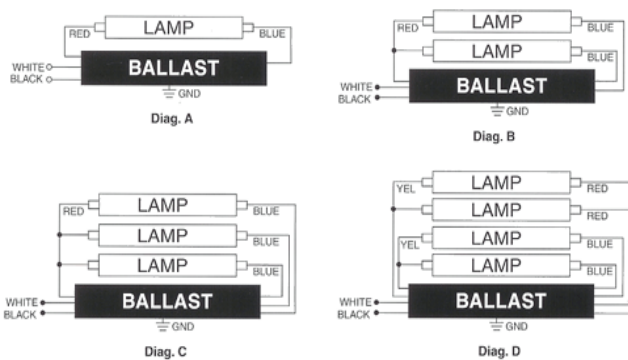

Enclosure

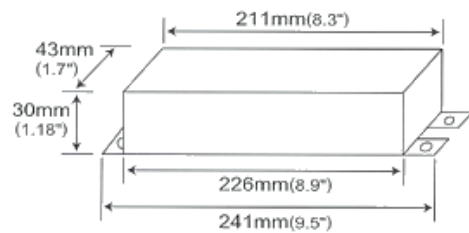

Lead Lengths (in.)

Black	25"		
White	25"		
Blue	31"		
Red	37"		
Yellow			
Blue/White			